



NMRA RP	
Standards Gauge	
Jun 25, 2026	RP-2 DRAFT

[Optional] Authors of this revision; include prior authors if minor revisions

# 1 General

The NMRA currently sells five styles of the Type I gauge as follows: N-Scale – Mark VI; HOn3-Scale – Mark III; HO-Scale – Mark V; Sn3-Scale – Mark III and O-Scale – Mark V. The Type II gauge (square gauge) is available for On3, On30, OO, S and Sn3.

## 5 1.1 Introduction and Intended Use (Informative)

The difference in the four styles of Type I gauges (III, IV, V & VI) is primarily the location of the tabs and slots on the gauge. The tabs on the top of the O scale Mark V gauge have been renamed from “Flangeways” to “Check-gauge”. Tabs on the HO Mark V gauge remain flangeways.

10 The instructions contained in RP-2 give you the proper method to check critical dimensions for track, wheels and coupler height. The Type I gauge can check clearance on tangent track.

## 1.2 References

This standard should be interpreted in the context of the following NMRA Standards, Technical Notes, and Technical Information.

### 1.2.1 Normative

- 15 • S-2 Couplers
- S-3.2 Track-Work Standard Scales
- S-4.2 Wheels Standard Scales
- RP-7.1 Tangent Track Centers and Clearance Diagrams

### 1.2.2 Informative

- 20 • None

## 1.3 Terminology

Term	Definition
Gauge	Device for measuring the magnitude, amount, or contents of something
Track gauge	Distance between the rails.
Check gauge	The back to back distance between wheels plus the flange width. This dimension is used to keep a wheel properly aligned when traversing a turnout frog or a crossing.
Stock rail	The outside rails of a turnout.
Points	The end of a turnout where one track nestles into the stock rail to determine the route of the train.
Frog	The place where the two rails intersect in a turnout or crossing.
Flangeway	A clearance between the rails where the wheel flange is captured.
Guard rail	A short section of rail parallel to the stock rail forming a flangeway to prevent a wheel from derailling at the frog of a turnout or a crossing.
Wing rail	A flangeway near the turnout frog.

## 2 Use of the Gauge

### 2.1 This GAUGE checks the following dimensions;

- 25 STANDARD S-3.2 Dimensions G, C, S, F, H, and P Type I or Type II gauge.  
 STANDARD S-4.2 Dimensions K B, N, and D Type I or Type II gauge.  
 RECOMENDED PRACTICE RP-7.1 Dimensions A, B, C, D, E, F, G, H, and P Type I gauge only.  
 The dimensions for RP-7.1 are prototype clearance dimensions from AREMA, now part of AAR. Do not confuse any of these letter designations with the same letters used in track and wheel dimensions. For clarification of dimension designations refer to S-3.2 and S-4.2

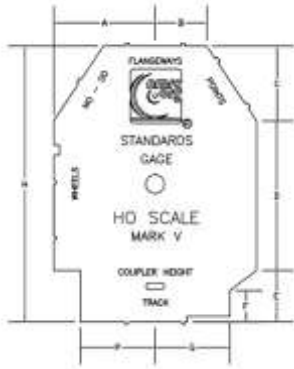

Fig 1 Type I Gauge

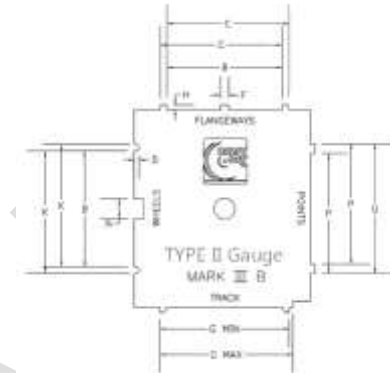

Fig 2 Type II

35 The Type I, Mark III gauge is not drawn in this RP but has the Flangeway NO-GO tab is between the Flangeway tabs along the top of the gauge.

NOTE: These GAUGES are intended only for checking STANDARD dimensions. For proto and fine scale dimensions refer to S-3.1 and S-4.1. For high rail refer to S-3.3 and S-4.3.

### 2.2 Components of a turnout

40 Figures 3 and 4 below identify the different Components of a turnout for use with the Instructions on the reverse side.

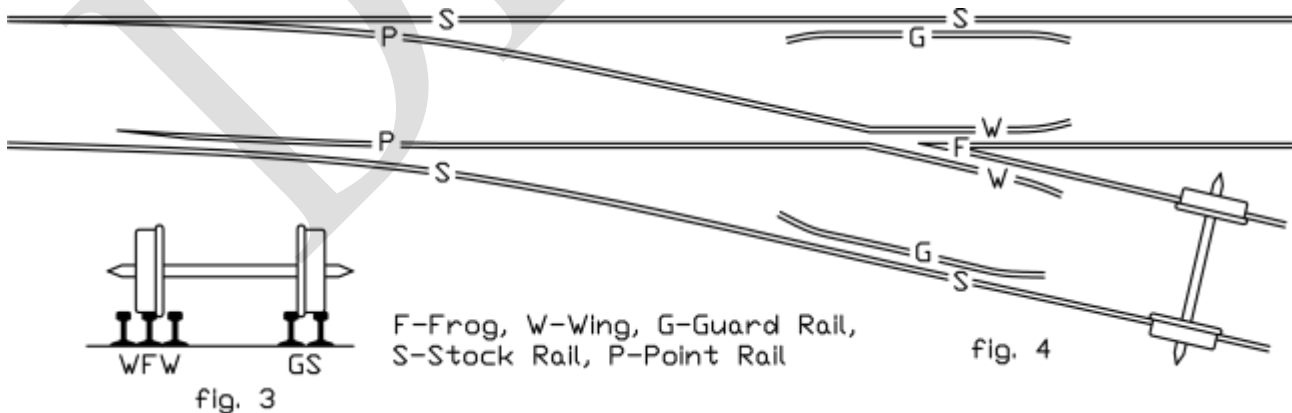

## 2.3 Checking track gauge

NOTE: The drawings below on how to use the NMRA Gauge are for the Type I, Mark V and Type II Mark IIIB gauge. Please check your gauge to insure you know which tab to use when checking a dimension.

45

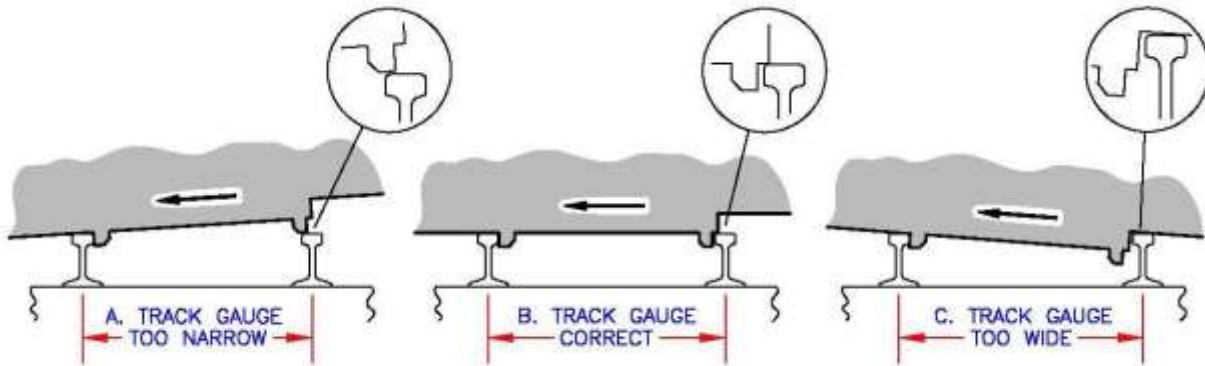

Fig 5

TRACK marks the side of the gauge used for checking Track Gauge through all track-work, including turnouts and other special work. Apply light pressure in the direction of the arrow. See figures A, B and C above for interpretation of results. (Note that the prongs of the Gauge must clear spikes.)

50

## 2.4 Check-gauge

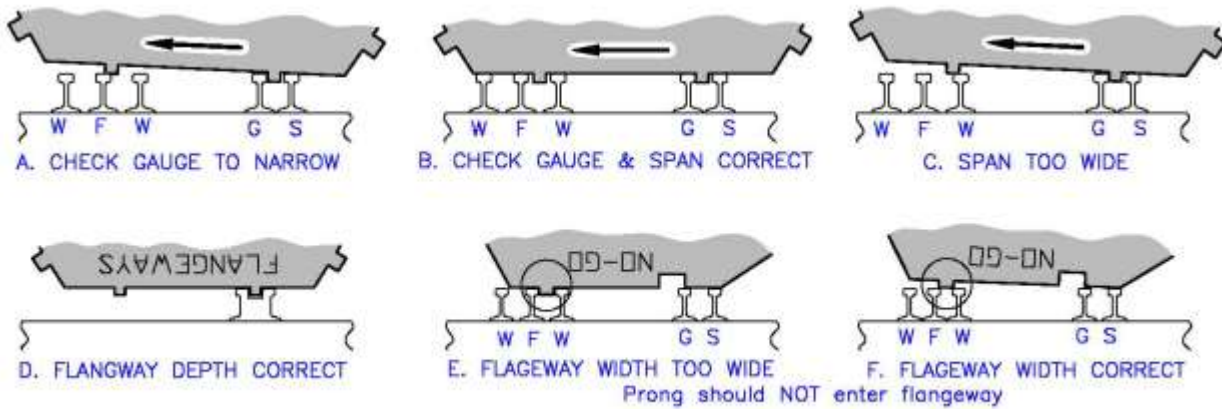

Fig. 6

Spacing of Guard Rails, Wing Rails and Frogs are checked with this side of the Gauge. Apply light side pressure toward the Frog and against the Guard Rail (see arrow). See figures A, B and C above for interpretation of results. Gauge prongs must clear all obstructions below the rail head as in figure D. Use NO-GO prong of Gauge to check Flangeway width at the Frog in figures E and F.

55

## 2.5 Points

POINTS are checked against excessive Spread by applying light side pressure against the Gauge side of the closed switch point rail as shown by the arrow. The opposite prong on the GAUGE dropping fully into the gap between the open switch point rail and the adjacent stock rail ensures adequate “Electrical Spread”, while dropping only to the step on the inside of the prong shows adequate Mechanical Spread. Clearance of the outside of the prong checks Track Gauge. Make this check along the entire length of the switch point rail.

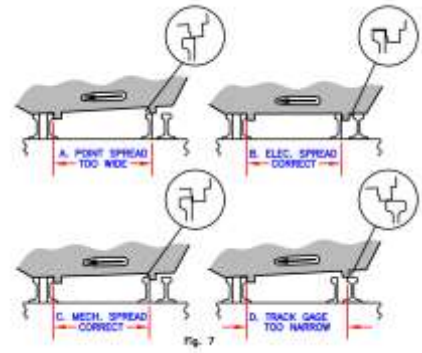

Fig 7

## 2.6 Wheels

Wheels are checked by applying light side pressure in the direction of the arrow. Each wheel must be checked - reverse the direction of pressure and check the other wheel. On Mark VI gauges, the flange notches are on the left with one in the lower left corner. See figures A, B, C and D below for interpretation of results. Use the wide NO-GO slot to check Tire Width as in E and F.

In checking wheels be sure that;

Wheel treads and flanges are free of “flash” and other projections.

Wheel flanges have proper contour, (see figure D).

Wheels spin freely in their trucks and free of wobble.

Where wobble is observed, check the wheel at several points to ensure that the wheel is within limits.

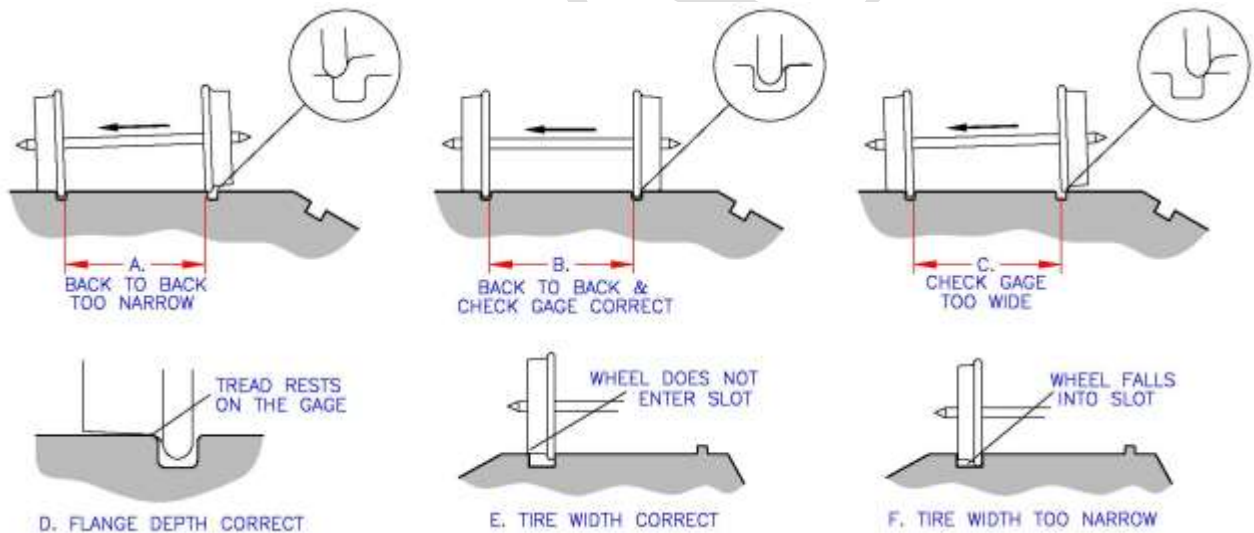

Fig 8

## 2.7 Clearance

Clearance may be checked only with the Type I GAUGE in the position shown in 2.3B above, seeing that no obstruction interferes with passage of the GAUGE along the track. **CAUTION:** This check is valid only for tangent track and curves of very wide radius. Refer to NMRA Recommended Practice RP-7.3 for increased clearances in sharper curvatures.

For oversized rolling stock and modern equipment snap on the plastic modern clearance gauge for your scale.

## 2.8 Coupler height

- 90 Coupler height is checked by mounting a coupler of your choice in the center of the slot and matching all other couplers to this height when the GAUGE is in the position shown in figure to the right.

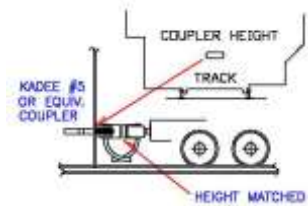

Fig 9

**WARNING: WHILE THESE GAUGES ARE VERY DURABLE, THEY ARE MEASURING DEVICES AND NOT METAL CUTTING TOOLS. THE USE OF THE GAUGE TO REMOVE METAL (EVEN SOFT SOLDER) WILL CAUSE WEAR ON THE MEASURING SURFACES AND DESTROY THE DEVICE AS A MEASURING INSTRUMENT.**

## 95 3 Document History

Date	Description
July 2019	Previous release
19-Aug-2023	Migrated to new template. Spelling, punctuation errors corrected and various clarifications added. New Fig 1 and Fig 2. Added a Note that the gauge is for standard dimensions check. Added text that for modern equipment add snap on plastic clearance gauge to check RP-7. For fine scale or proto refer to S-4.1 Created TN-2 from this version of RP-2 to have a two page one sheet of paper instruction to pack with gauges for shipping. Errors on gauge envelope were addressed. Approved by Board of Directors. JM Juett
15-Jan-2024	Improved drawings sections 2.3, 2.4, 2.5 & 2.6. Added drawing in section 2.8 JM Juett
3-Dec-2024	Corrected Figure 7 drawing. JM Juett
11-Dec-2025	Corrected check-gauge Figure 6 drawing in section 2.4. Improved drawings Fig 3 & Fig 4. Spelling of gage changed to gauge. Various typos corrected. New NMRA logo. Retired TN-2 in favor of this document with more complete information and to reduce potential errors in maintaining two documents where some of the content must be the same. JM Juett
25-Jun-2026	Added explanation in Section 2.6 for checking wheel gauge on Mark VI gauges. Corrected Fig 8. Other minor format changes. JM Juett

The most current version of this RP can be found at

[https://www.nmra.org/sites/default/files/standards/sandrp/General/RP/rp-2\\_track\\_gauges.pdf](https://www.nmra.org/sites/default/files/standards/sandrp/General/RP/rp-2_track_gauges.pdf)

# Important Notices and Disclaimers Concerning NMRA Standards Documents

The Standards (S), Recommended Practices (RP), Technical Note (TN), and Technical Information (TI) documents of the National Model Railroad Association ("NMRA Standards documents") are made available for use subject to important notices and legal disclaimers. These notices and disclaimers, or a reference to this page, appear in all standards and may be found under the heading "Important Notices and Disclaimers Concerning NMRA Standards Documents."

## Notice and Disclaimer of Liability Concerning the Use of NMRA Standards Documents

NMRA Standards documents are developed within the Standards and Conformance Department of the NMRA in association with certain Working Groups, members, and representatives of manufacturers and sellers. NMRA develops its standards through a consensus development process, which brings together volunteers representing varied viewpoints and interests to achieve the final product. NMRA Standards documents are developed by volunteers with modeling, railroading, engineering, and industry-based expertise. Volunteers are not necessarily members of NMRA, and participate without compensation from NMRA.

NMRA does not warrant or represent the accuracy or completeness of the material contained in NMRA Standards documents, and expressly disclaims all warranties (express, implied and statutory) not included in this or any other document relating to the standard or recommended practice, including, but not limited to, the warranties of: merchantability; fitness for a particular purpose; non-infringement; and quality, accuracy, effectiveness, currency, or completeness of material. In addition, NMRA disclaims any and all conditions relating to results and workmanlike effort. In addition, NMRA does not warrant or represent that the use of the material contained in NMRA Standards documents is free from patent infringement. NMRA Standards documents are supplied "AS IS" and "WITH ALL FAULTS."

Use of NMRA Standards documents is wholly voluntary. The existence of an NMRA Standard or Recommended Practice does not imply that there are no other ways to produce, test, measure, purchase, market, or provide other goods and services related to the scope of the NMRA Standards documents. Furthermore, the viewpoint expressed at the time that NMRA approves or issues a Standard or Recommended Practice is subject to change brought about through developments in the state of the art and comments received from users of NMRA Standards documents.

In publishing and making its standards available, NMRA is not suggesting or rendering professional or other services for, or on behalf of, any person or entity, nor is NMRA undertaking to perform any duty owed by any other person or entity to another. Any person utilizing any NMRA Standards document, should rely upon their own independent judgment in the exercise of reasonable care in any given circumstances or, as appropriate, seek the advice of a competent professional in determining the appropriateness of a given NMRA Standards document.

IN NO EVENT SHALL NMRA BE LIABLE FOR ANY DIRECT, INDIRECT, INCIDENTAL, SPECIAL, EXEMPLARY, OR CONSEQUENTIAL DAMAGES (INCLUDING, BUT NOT LIMITED TO: THE NEED TO PROCURE SUBSTITUTE GOODS OR SERVICES; LOSS OF USE, DATA, OR PROFITS; OR BUSINESS INTERRUPTION) HOWEVER CAUSED AND ON ANY THEORY OF LIABILITY, WHETHER IN CONTRACT, STRICT LIABILITY, OR TORT (INCLUDING NEGLIGENCE OR OTHERWISE) ARISING IN ANY WAY OUT OF THE PUBLICATION, USE OF, OR RELIANCE UPON ANY STANDARD OR RECOMMENDED PRACTICE, EVEN IF ADVISED OF THE POSSIBILITY OF SUCH DAMAGE AND REGARDLESS OF WHETHER SUCH DAMAGE WAS FORESEEABLE.

## Translations

NMRA's development of NMRA Standards documents involves the review of documents in English only. In the event that an NMRA Standards document is translated, only the English version published by NMRA is the approved NMRA Standards document.

## Official Statements

A statement, written or oral, that is not processed in accordance with NMRA policies for distribution of NMRA communications, or approved by the Board of Directors, an officer or committee chairperson, shall not be considered or inferred to be the official position of NMRA or any of its committees and shall not be considered to be, nor be relied upon as, a formal position of NMRA.

## Comments on Standards

Comments for revision of NMRA Standards documents are welcome from any interested party, regardless of membership. However, **NMRA does not provide interpretations, consulting information, or advice pertaining to NMRA Standards documents.**

Suggestions for changes in documents should be in the form of a proposed change of text, together with appropriate supporting comments. Since NMRA standards represent a consensus of concerned interests, it is important that any responses to comments and questions also receive the concurrence of a balance of interests. For this reason, NMRA, its departments, Working Groups or committees cannot provide an instant response to comments, or questions except in those cases where the matter has previously been addressed. For the same reason, NMRA does not respond to interpretation requests. Any person who would like to participate in evaluating comments or in revisions to NMRA Standards documents may request participation in the relevant NMRA working group.

## Laws & Regulations

Users of NMRA Standards documents should consult all applicable laws and regulations. Compliance with the provisions of any NMRA Standards document does not constitute compliance to any applicable regulatory requirements. Implementers of the standard are responsible for observing or referring to the applicable regulatory requirements. NMRA does not, by the publication of NMRA Standards documents, intend to urge action that is not in compliance with applicable laws, and NMRA Standards documents may not be construed as doing so.

## Copyrights

NMRA Standards documents are copyrighted by NMRA under US and international copyright laws. They are made available by NMRA and are adopted for a wide variety of both public and private uses. These include both use, by reference, in laws and regulations, and use in private self-regulation, standardization, and the promotion of modeling, structural and engineering practices and methods. By making NMRA Standards documents available for use and adoption by public authorities and private users, NMRA does not waive any rights in copyright to the NMRA Standards documents.

## IMPORTANT NOTICE

NMRA Standards documents do not guarantee or ensure safety, security, health, or environmental protection, or ensure against interference with or from other systems, devices or networks. NMRA Standards documents development activities consider research and information presented to the standards development group in developing any safety recommendations. Other information about safety practices, changes in technology or technology implementation, or impact by peripheral systems also may be pertinent to safety considerations during implementation of the standard. Implementers and users of NMRA Standards documents are responsible for determining and complying with all appropriate safety, security, environmental, health, and interference protection practices and all applicable laws and regulations.